

Soccer & Rugby |



Competition Soccer Goal Post Free Hanging System

Professional football goal type, Dimension 7.32 x 2.44 m. Compliant with the latest FIFA requirements. The goal post frames (100 x 120 mm), with a 2.5 mm wall thickness, are fitted with our integrated net suspension system. Goal corners (with corner strengthening on the insides). The goalposts are joined to the crossbar by means of a connecting plug and this guarantees enormous stability along with the option of dismantling the goal (for example for space-saving storage). The net hooks are integrated directly into the goal frame. This means that there are no external hooks, screwed or welded on, the net can be hung up or taken down easily and there is a significantly reduced danger of injury. Two net support poles are included. The goal post is white powder coated.

- Order No. 110120** Powder coated
- Order No. 110130** Aluminium surface

Ground Socket Standard And Special

The standard ground socket for the soccer goal post is made from aluminium. The socket is designed to match the oval profile 120x100 of the soccer goal post. The cover of this socket cannot be coated. It measures a total length of 450 mm. The insertion length is 400 mm. The ground socket is equipped with a compartment to store possible soiling without effecting the height of the post.

Order no. 110140

The special ground socket for the soccer goal post is made from aluminium. The socket is designed to match the oval profile 120x100 of the soccer goal post. The cover of this socket can be coated with the surrounding material. It measures a total length of 450 mm. The insertion length is 400 mm. The ground socket is equipped with a compartment to store possible soiling without effecting the height of the post.

Order no. 110150

Order no. 110160

The standard ground socket for the soccer goal net pole post is made from aluminium. The socket is designed to match the round tube with a diameter of 56 mm of the net pole. The cover of this socket cannot be coated. It measures a total length of 350 mm. The insertion length is 300 mm. The ground socket is equipped with a compartment to store possible soiling without effecting the height of the post.

Order no. 110100,110120,110130

Order no. 110170

The special ground socket for the soccer goal net pole is made from aluminium. The socket is designed to match the round tube with a diameter of 56 mm of the net pole. The cover of this socket can be coated with the surrounding material. It measures a total length of 350 mm. The insertion length is 300 mm. The ground socket is equipped with a compartment to store possible soiling without effecting the height of the post

Order no. 110100,110120,110130



Standard Ground Socket



Special Ground Socket

*Subject to technical alterations



Bar Frame

The bar frame is made from a special aluminium profile. Its cross section is 50x50x3 mm. The profile is equipped with a slot to fix the net hooks in the profile. The bar frame consists of three parts. The two side parts and the rear crossbar. The projection of the bar frame is 2.00 m. All screws to assemble the bar frame are made from stainless steel and are supplied together with the item.

Order No. 110121



Bar Frame With Attached Net Poles

The bar frame with net poles is made from a special aluminium profile. Its cross section is 50x50x3 mm. The profile is equipped with a slot to fix the net hooks in the profile. The bar frame consists of three parts. The two side parts and the rear crossbar. At the back of the side parts there are sleeves attached for the net poles. The projection of the bar frame is 2.00 m. All screws to assemble the bar frame are made from stainless steel and are supplied together with the item. The bar frame with net poles is made from a special aluminium profile. Its cross section is 50x50x3 mm. The profile is equipped with a slot to fix the net hooks in the profile. The bar frame consists of three parts. The two side parts and the rear crossbar. At the back of the side parts there are sleeves attached for the net poles. The projection of the bar frame is 2.00 m. All screws to assemble the bar frame are made from stainless steel and are supplied together with the item.

Order No. 110122

*Subject to technical alterations



Training Goal Post Aluminium Surface

The practice soccer goal post is made of high-grade aluminium profiles. The inside dimension of this goal are 7.32x2.44 m. The front frame of the goal is made from oval 120x100x2.5 mm profile. The bottom frame is made from a rectangular hollow 80x60x3 mm. The top projection of the goal is 0.8 m. The lower projection measures 2.0 m. The item is available in a fully welded version and in a dismantle version for export. The goal is extremely robust and durable. It is equipped with the INTERLOCK net hook system, which ensures that the nets hangs perfectly.

- Order No. 110040** Dismantle
- Order No. 110030** Fully welded

Practice Soccer Goal Dismantle Version White Powder Coated



The practice soccer goal post is made of high-grade aluminium profiles. The inside dimension of this goal are 7.32x2.44 m. The front frame of the goal is made from oval 120x100x2.5 mm profile.

The bottom frame is made from a rectangular hollow 80x60x3 mm. The top projection of the goal is 0.8 m. The lower projection measures 2.0 m. The item is dismantle for export.

The goal is extremely robust and durable. It is equipped with the INTERLOCK net hook system, which ensures that the nets hangs perfectly. The front frame of this goal post is powder coated in white colour.

Order No. 110050

*Subject to technical alterations



Transport Wheel (Welded To The Post)

The transport wheels for goal posts are made from polyamide. The wheels measure a diameter of 200 mm. The support structure is realized by aluminium. The wheels are mounted with stainless steel screws. The item is directly welded to the goal post.

Order No. 110060



Transport Wheel For Goal Post

The transport wheels for goal posts are made from polyamide. The wheels measure a diameter of 200 mm. The support structure is realized by aluminium. The wheels are mounted with stainless steel screws. The item is directly can be fixed to the goal post on site.

Order No. 110061



Counterweights

The counterweights are made from aluminium. The weights are fixed on the back side of the bar frame. The weights provide sufficient weight to prevent the goal from toppling over in accordance with the EN standard. The wheels for the counterweights are made from polyamide. They measure a diameter of 200 mm. The wheels are used to move the goal around comfortably.

Order No. 110070

INFO - SECURING GOALS

Caution: danger of falling over! According to the regulations of local accident prevention federations and DIN/EN, movable goals must be secured against falling over. For example, with a junior goal with a 1.5 m base depth, a 125 kg counterweight is necessary to ensure a stability of 1100 N in accordance with DIN/EN.

For junior goals with ground frames of rectangular profiles

100 kg – for a depth of 2 m

125 kg – for a depth of 1.5 m

Order No. 110067 100 Kg counter weight. For mobile goal post 7.32 x 2.44 m. Projection 2.00 m.

Order No. 110069/1.5 125 Kg counter weight. For junior goal post 5.00 x 2.00 m. Projection 1.50 m

Order No. 110069/2.0 100 Kg counter weight. For junior goal post 5.00 x 2.00 m. Projection 2.00 m



Ground Anchors

The ground anchor is made from aluminium. The aluminium is equipped with a thread for an M 16 screw. The ground anchor is used to fix mobile goal posts to the floor. One set consists of 4 aluminium anchors and 4 stainless steel screws.

Order No. 111210

*Subject to technical alterations



Junior Football Goals (5 X 2 M)

The Junior football goal post is made of high-grade aluminium profiles. The inside dimension of this goal are 5x2m. The front frame of the goal is made from oval 120x100x2.5 mm profile. The bottom frame is made from a rectangular hollow 80x60x3 mm. The top projection of the goal is 0.8 m. The lower projection can be chosen between three options (1.0 m, 1.5 m, 2.0 m). The item is available in a fully welded version and in a dismantle version for export. The goal is extremely robust and durable. It is equipped with the INTERLOCK net hook system, which ensures that the nets hangs perfectly.

- Order No. 110210** Projection 1.00 m
- Order No. 110220** Projection 1.50 m
- Order No. 110230** Projection 2.00 m
- Order No. 110240** Projection 1.00 m (Dismantle Version)
- Order No. 110250** Projection 1.50 m (Dismantle Version)
- Order No. 110260** Projection 2.00 m (Dismantle Version)
- Order No. 112071** Frame 3.66 x 1.80 m Projection 0.80/1.50 m welded on one piece
- Order No. 112072** Frame 3.66 x 1.80 m Projection 0.80/1.50 m (Dismantle Version)
- Order No. 110251** Projection 1.50 m (Dismantle Version, Frame white powder coated)



*Subject to technical alterations



Futsal Goal Post

The futsal goal is made from special aluminium profiles. The profiles for the front frame are square hollow with a cross section of 80 x 80 x 2.5 mm. The profile is equipped with an integrated net suspension system. The bar frame is made from a 50 x 50 x 3 mm square hollow with integrated net suspension as well. The goal measures 3.00 m in width and 2.00 m in height. The projection is 0.80 m at the top and 1.00 m at the bottom. The goal is available fully welded or dismantle for export.

Order No	Type	Colour
110390	Fully welded	Aluminium
110400	Dismantle	Aluminium
110410	Fully welded	White
110420	Dismantle	White

*Subject to technical alterations



Futsal Goal Post Foldable



The futsal goal foldable is made from special aluminium profiles. The profiles for the front frame are square hollow with a cross section of 80 x 80 x 2.5 mm. The profile is equipped with an integrated net suspension system. The bar frame is made from a 50 x 50 x 3 mm square hollow with integrated net suspension as well. The goal measures 3.00 m in width and 2.00 m in height. The projection is 0.80 m at the top and 1.00 m at the bottom. The projection can be folded inwards and upwards to minimize the storage space for this goal post. The goal is available fully welded or dismantle for export.

Order No	Type	Colour
110370	Fully welded	Aluminium
110371	Dismantle	Aluminium
110380	Fully welded	White
110381	Dismantle	White

*Subject to technical alterations



Hobby Soccer Goal Post

The hobby soccer goal is made from special aluminium profiles. The profiles for the front frame are square hollow with a cross section of 120x100x2.5 mm. The profile is equipped with an integrated net suspension system. The bar frame is made from a 50x50x3 mm square hollow with integrated net suspension as well. The goal measures 3.00 m in width and 2.00 m in height. The projection is 0.80 m at the top and 1.00 m at the bottom. The goal is available fully welded or dismantle for export.

Order No	Type	Colour
110430	Fully welded	Aluminium
110430/DS	Dismantle	Aluminium
110430/DS/FD	Foldable	Aluminium
110430/W	Fully welded	White
110430/W/DS	Dismantle	White
110430/W/DS/FD	Foldable	White

*Subject to technical alterations

Mini Goal Post Fully Welded

The mini soccer goal post is made from special aluminium profiles. The profiles for the front frame are square hollow with a cross section of 80 x 80 x 2.5 mm. The profile is equipped with an integrated net suspension system. The bar frame is made from a 40x40x3 mm square hollow. The projection of the mini soccer goal post is 0.5 m at the top and at the bottom. The goal is available fully welded or dismantle for export. Front frames also available in oval profile 100 x 120 mm.

Order No	Type	Dimension	Net type	Colour
111240	Football goal	120 x 80cm		
111270	Football goal	180 x 120cm		
111300	Football goal	150 x 100cm		
111310	Football goal	240 x 160cm		
111320	Net for Football goal	120 x 80cm	PP 4mm	Green
111330	Net for Football goal	180 x 120cm	PP 4mm	Green
111331	Net for Football goal	150 x 100cm	PP 4mm	Green
111340	Net for Football goal	240 x 160cm	PP 4mm	Green



Mini Goal Post Foldable version

The mini soccer goal post is made from special aluminium profiles. The profiles for the front frame are square hollow with a cross section of 80 x 80 x 2.5 mm. The profile is equipped with an integrated net suspension system. The bar frame is made from a 40 x 40 x 3 mm square hollow. The projection of the mini soccer goal post is 0.5 m at the top and at the bottom. The net supporters at the side and the bar frame can be folded. This folding allows to minimize the storage space of this post. The goal is available fully welded or dismantle for export.

Front frames are also available in oval profile 100 x 120 mm.

- Order No. 111250** 120 x 80 cm.
- Order No. 111260** 150 x 100 cm.
- Order No. 111280** 180 x 120 cm.
- Order No. 111291** 240 x 160 cm.

*Subject to technical alterations



Hobby Soccer Goal Post "Close Back"

The hobby soccer goal post 'close back' is made from high grade aluminium profiles. The goal measures inner dimension of 3x2 m. The cross section of the post is 120x100x2.5 mm. The goal profile is completely made from aluminium and welded in one piece. The back section consist of 38 mm round tubes. The goal post is equipped with an aluminium basketball backboard and basketball ring.

On request, the goal post are also available with 80x80 sq post.

Order No. 111170



Hobby Soccer Goal Post with Basketball Stand

Hobby Soccer Goal Post (3 x 2 m). "Closed Back" with Basketball Stand. Fully welded recreational goal made of high-grade aluminium profiles. Due to its robust construction, the goal is almost completely vandalism-proof and as a result well suited for use on public playing fields or in playgrounds. The goal frame is made from our oval profiles (120 x 100 mm) with a wall thickness of 2.5 mm. The rear wall of our recreational goal consists of fully inserted round tubes with a diameter of 38 mm and a wall thickness of 3.0 mm. Supplied with 4 ground anchors.

Order No. 111180

*Subject to technical alterations



The Futsal & Basketball post with panel

The Futsal & Basketball post with panel is made from special aluminium profile structure. The panels are realized from HDPE. The structure measures a total width of 8.7 m and a height of 3.8 m. The panels are UV stabilized and measure a thickness of 15 mm. They are available in assorted colours. The structure is realized from sturdy 80x80 mm square hollow profiles. The futsal goal post measures the standard dimension of 3.0 x 2.0 m. The back portion of the goal is also made from aluminium. Therefore, no net is need for this futsal goal post. The backboard measures 1.2 x 0.9 m. The aluminium backboard is made from special aluminium profiles. It is white powder coated. The backboard is also equipped with a non-foldable ring and net. The ring measures an inside diameter of 45 cm. The ring is galvanized and orange powder coated. The net is made from nylon and measures a thickness of 6 mm.

Order No. 119982

On request the item can be produced in different dimension!



*Subject to technical alterations



Transport Cart for Soccer Goal Post

Transport carts for soccer goal post are made of high-grade aluminium profiles. The aluminium construction guarantees a high loading capacity along with simple and problem-free use. The goal post can easily be stored with our transport cart.

Order No. 110125 Transport Trolley for Competition Soccer Goal Post

Order No. 110126 Transport Trolley for Training Goal Post Foldable

*Subject to technical alterations



Beach Soccer Post - Type 1

The portable beach soccer goal post is made of high-grade aluminium profiles. The inside dimension of this goal are 5.5x2.2 m. The front frame of the goal is made from oval 120x100x2.5 mm profile. The bottom frame is made from a rectangular hollow 80x60x3 mm. The top projection of the goal is 0.8 m. The lower projection can be chosen between three options (1.0 m, 1.5 m, and 2.0 m). The goal is completely powder coated in yellow colour. The item is available in a fully welded version and in a dismantle version for export. The goal is extremely robust and durable. It is equipped with the INTERLOCK net hook system, which ensures that the nets hangs perfectly.

Order No. 114000 Portable Beach Soccer Goal (5.5 m)
Order No. 113292 Frame dimension 3.00 x 2.00 m



Beach Soccer Goal Post - Type 2

Beach Soccer Goal free hanging net. Portable (5.5 m) The portable beach soccer goal post is made of high-grade aluminium profiles. The inside dimension of this goal are 5.5x2.2 m. The front frame of the goal is made from oval 120x100x2.5 mm profile. The bottom frame is made from a rectangular hollow 80x60x3 mm. The top projection of the goal is 0.8 m. The lower projection can be chosen between three options (1.0 m, 1.5 m, and 2.0 m). Our goal post is completely powder coated in yellow colour. The item is available in a fully welded version and in a dismantle version for export. The goal is extremely robust and durable. It is equipped with the INTERLOCK net hook system, which ensures that the nets hang perfectly.

Order No. 114005

*Subject to technical alterations



Beach Soccer Goal Fixed Type

The beach soccer goal fixed type is made from high-grad aluminium profiles. The frame of the goal post measure a cross section of 120x100x2.5 mm. The goal is yellow powder coated. It is equipped with the INTERLOCK net hook system, which ensures that the net hangs perfectly. The ground sockets are not included in this item. The goal is available in two sizes:

Order No 114010 5.5x2.2 m

Order No 113391 3.0x2.0 m

The socket with adapter for beach soccer goal post is made from aluminium. One side of the adapter fits in the ground socket, whereas the other side fits into the beach soccer goal post. The adapter is used to fix the goal with the ground socket.

Order No 110254

The beach soccer net is made from knotless high tenacity PP. The mesh width is 100 mm. The net thickness is 4 mm. IT stands out because of its high mesh rigidity and energy absorption. The net can be fixed easily due to its light weight and flexibility. It is available in different sizes to match the goal post.

Order No 114015 5.5x2.2 m

Order No 114016 3.0x2.0 m

The beach soccer marking kit is used to mark out the court. The lines are 37 and 28 m long. The kit is available in various colours.

Order No. 114040



*Subject to technical alterations

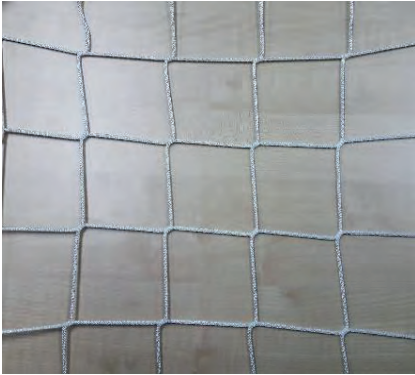

Futsal Net

The Futsal goal net is made from knotless high tenacity PP. It measures 3 m width and 2 m in height. The projection is 80 cm on top and 100 cm at the bottom. The mesh width is 100 mm. The net stands out because of its high mesh rigidity and high energy absorption. It can be fixed easily due to its light weight and flexibility. At the same time the net is also very abrasion resistant. The net fulfils the requirements of DIN EN 749. The net is available in assorted colours and thicknesses.

- Order No. 110450** Green colour 4 mm
- Order No. 110460** White colour 4 mm



Junior Goal Net

The junior goal net is made from knotless high tenacity PP. It measures 5 m width and 2 m in height. The projection is 80 cm on top and 100/150/200 cm at the bottom. The mesh width is 100 mm. It has a thickness of 4 mm. The net stands out because of its high mesh rigidity and high energy absorption. It can be fixed easily due to its light weight and flexibility. At the same time the net is also very abrasion resistant. The net fulfils the requirements of DIN EN 749. The net is available in assorted colours.

Order No	Projection	Colour
110910	0.8 / 1.0	Green
110940	0.8 / 1.0	White
111000	0.8 / 1.5	White
111010	0.8 / 1.5	Green
111010	0.8 / 2.0	White
111020	0.8 / 2.0	Green

Maximum resistance and reliability

This new line of knotless nets made of high tenacity polypropylene represents a new concept of a net and it has been possible thanks to the use of the latest technologies.

All gold line nets have been produced according to technical specifications specified in every European Norm regarding sport nets.

- Recyclable 100%
- Specific weight 0.91, lighter than water
- 100% inert (does not produce bacteria).
- Anti-allergic 100%
- Not eatable by any insects (moths, for example)
- Does not accumulate static electricity
- High resistance to abrasion
- High protection against ultraviolet rays (lost of energy inferior to the polyamid nets)
- keeps the tenacity in acid and alkaline environments
- Low absorption of water (0.05%, it is one of the lowest factors in all the fibres)
- Good thermic insulator
- It does not affect any acid except xilen at the boiling point
- Being a non absorbent fibre it is resistant to grime and offers the highest protection for stains
- Easy assembly
- It is not necessary to stabilize it dimensionally through thermo-fixing of the knots. It does not have knots (new technology). There is no possibility of knots moving.
- They come in different colours (green, blue,red,etc.)

Soccer Goal Net for Training Post

Dimension 7.50 x 2.50 m, Top depth 0.80 m, and bottom depth 2.00 m Knot-less high tenacity Nylon, Thickness 4 mm, Mesh 100 mm White colour.

Order No. 111051

Soccer Goal Net for Training Goal Post

Dimension 7.50 x 2.50 m, Top depth 0.80 m, and bottom depth 2.00 m Knot-less high tenacity Polypropylene, Thickness 4 mm, Mesh 4 mm White colour.

Order No. 111070

*Subject to technical alterations



Competition Soccer Nets

The competition soccer goal net is made from knotless high tenacity PP. It measures 7.32 m width and 2.44 m in height. The projection is 80 cm on top and 100/150/200 cm at the bottom. The mesh width is 100 mm. It has a thickness of 4 mm. The net stands out because of its high mesh rigidity and high energy absorption. It can be fixed easily due to its light weight and flexibility. At the same time the net is also very abrasion resistant. The net fulfils the requirements of DIN EN 749. The net is available in assorted colours.

Order No	Projection	Colour
111090	2.0 / 2.0	Green
111100	2.0 / 2.0	White



Soccer Goal Net Hexagonal

The competition soccer goal net hexagonal is made from knotless high tenacity PP. It measures 7.32 m width and 2.44 m in height. The projection is 80 cm on top and 100/150/200 cm at the bottom. The mesh width is 120 mm. It has a thickness of 4 mm. The net stands out because of its high mesh rigidity and high energy absorption. It can be fixed easily due to its light weight and flexibility. At the same time the net is also very abrasion resistant. The net fulfils the requirements of DIN EN 749. The net is available in assorted colours.

Order No	Projection	Colour
111110	2.0 / 2.0	White
111120	2.0 / 2.0	Green
111121	2.0 / 2.0	White/ Green
111122	2.0 / 2.0	White/ Blue
111123	2.0 / 2.0	White/ Red
111124	2.0 / 2.0	Blue/ Red

*Subject to technical alterations



Two Colour Soccer Goal Net

The competition soccer goal net hexagonal is made from knotless high tenacity PP. It measures 7.32 m width and 2.44 m in height. The projection is 80 cm on top and 100/150/200 cm at the bottom. The mesh width is 120 mm. It has a thickness of 4 mm. The net stands out because of its high mesh rigidity and high energy absorption. It can be fixed easily due to its light weight and flexibility. At the same time the net is also very abrasion resistant. The net fulfils the requirements of DIN EN 749. The net is available in assorted colours.

Order No	Colour	Size	Projection
119515	Green/ White	7.5 / 2.5	0.8 / 2.0
119520	Green/ White	7.5 / 2.5	2.0 / 2.0
119525	Red/ White	7.5 / 2.5	0.8 / 2.0
119530	Red/ White	7.5 / 2.5	2.0 / 2.0
119535	Blue/ White	7.5 / 2.5	0.8 / 2.0
119540	Blue/ White	7.5 / 2.5	2.0 / 2.0
119545	Green/ White	5.15 / 2.05	0.8 / 1.0
119550	Green/ White	5.15 / 2.05	0.8 / 1.5
119565	Red/ White	5.15 / 2.05	0.8 / 1.0
119570	Red/ White	5.15 / 2.05	0.8 / 1.5
119575	Blue/ White	5.15 / 2.05	0.8 / 1.0
119580	Blue/ White	5.15 / 2.05	0.8 / 1.5
119585	Green/ White	3.0 / 2.0	0.8 / 1.0
119600	Red/ White	3.0 / 2.0	0.8 / 1.0
119605	Blue/ White	3.0 / 2.0	0.8 / 1.0

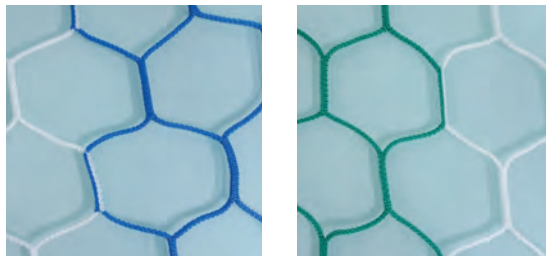
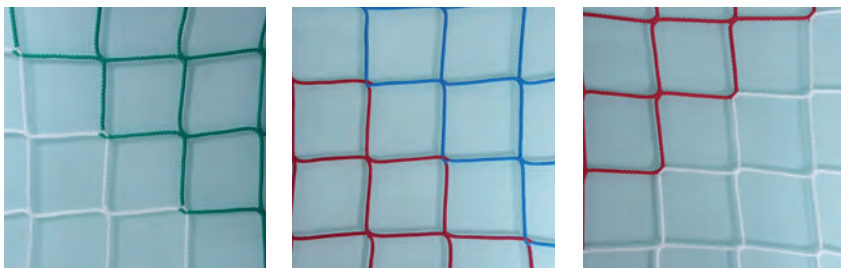

*Subject to technical alterations



Soccer Goal Net "Dralo"

The Soccer goal net is made from steel wire ropes. The net measures a width of 300 cm and a height of 200 cm. The projection rises from 90 cm on top to 110 cm at the bottom. The mesh width is approx.. 120 mm. The mesh is in square boxes.

Order No 119850

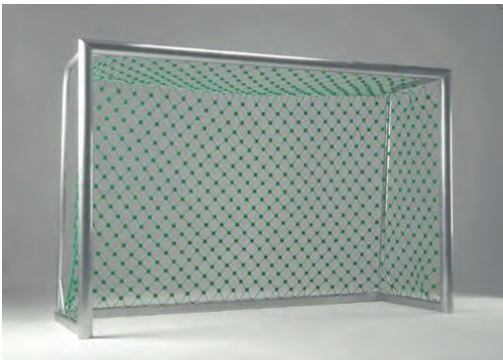

Soccer Goal Net "Hercules"

The soccer goal net 'Hercules' is vandalism proof. It is made from 5 mm thick Hercules rope. The net measures a width of 300 cm and a height of 200 cm. The projection rises from 90 cm on top to 110 cm at the bottom. The mesh width is approx.. 110 mm. The net is diagonal formation.

Order No. 119860



Futsal Backstop System

Distance post to post approx. 5 m. Backstop post made from special aluminium oval profile 100 x 120 x 2.5 mm. Projection 50 cm. Included ground sockets standard and spacer on the ground for fixing the net. The net is made from Polypropylene thickness 4 mm Mesh 100 mm and green colour. Included pull up devices for the net. This backstop system is available in different heights.

Order No. 119320

Order No. 119300 Weight 200 gram per meter attached to the net

*Subject to technical alterations



Backstop Post For Soccer - Height 4, 5, 6, 7, 8m

The backstop is made from special aluminium profiles. The backstop posts are fitted in ground sockets. The cross section of the post measures 120 x 100 x 2.5 mm. The ground sockets measure a length of 800 mm. The net is made from high tenacity knotless PP. The mesh width is 100 mm. It is green in colour. The net is fixed onto stainless steel wires. The stainless steel wires can be fixed with the also supplied turnbuckles. Usually the backstop measures a length of 25 m. Other lengths are available on request.

*Subject to technical alterations



*Subject to technical alterations



Backstop Net

The backstop net is made from knotless high tenacity polypropylene. The nets are 100 per cent recyclable. Their specific weight is lighter than water. It does not produce bacteria and is anti-allergic. It is not edible for insects. It also doesn't accumulate static electricity. It keeps the tenacity in acid and alkaline environments. It hardly absorbs any water and is a good thermal insulator. The knots are thermos fixed. Therefore, it is not possible to move the knots. It has a high resistance to abrasion.

The net is available in assorted colours in various thicknesses and mesh widths:

Order No	Colour	Mesh Width	Thickness
119190	Green	45mm	2.3mm
119100	Green	45mm	3.0mm
119080	White	45mm	3.0mm
119215	Green	100mm	3.0mm
119230	Green	120mm	3.0mm
119140	Green	45mm	4.0mm
119275	Green	100mm	4.0mm
119285	Green	120mm	4.0mm
119270	White	100mm	4.0mm
119280	Black	100mm	4.0mm

Maximum resistance and reliability

This new line of knotless nets made of high tenacity polypropylene represents a new concept of a net and it has been possible thanks to the use of the latest technologies.

All gold line nets have been produced according to technical specifications specified in every European Norm regarding sport nets.

- Recyclable 100%
- Specific weight 0.91, lighter than water
- 100% inert (does not produce bacteria)
- Anti-allergic 100%
- Not eatable by any insects (moths, for example)
- Does not accumulate static electricity
- High resistance to abrasion
- High protection against ultraviolet rays (lost of energy inferior to the polyamid nets)
- Keeps the tenacity in acid and alkaline environments
- Low absorption of water (0.05%, it is one of the lowest factors in all the fibres)
- Good thermal insulator
- It does not affect any acid except xilen at the boiling point
- Being a non absorbent fibre it is resistant to grime and offers the highest protection for stains
- Easy assembly
- It is not necessary to stabilize it dimensionally through thermo-fixing of the knots. It does not have knots (new technology). There is no possibility of knots moving.
- They come in different colours (green, blue, red, etc.)

*Subject to technical alterations



AFN Multi Court

The multi play court is made from special aluminium profiles. The court measure a height of 3 m. The panels are made from a double walled panel profile. It measures a thickness of 2.3 mm. The panels are boarded with a U-profile, which as a radius of 2 mm. The panels are completely welded. They measure a height of 1 meter. The connection between panel and post is equipped with a rubber layer. The rubber layer reduces the noise level. The freestanding version includes the counterweights (approx. 20 kg). For the ground socket version, the sockets are included. The door of the court measures a width of 1 m and a height of 2 m. The door is fully welded and opens outwards.

The net is hung with stainless steel wires on top. The net is joined with the wire via nylon hooks. At the sides the INTERLOCK net hook system keeps it in place. The net is made from polypropylene (PP) and measures a thickness of 4 mm. The mesh width is 100 mm.

On request different equipment, such as volleyball equipment, basketball equipment, mini goals, tennis equipment or badminton equipment, can be fixed to the court. The court also can be done in powder coated finish.

Our AFN integrated net hooks are used for the net suspension. In the standard version, the nets are made of polypropylene (PP), 4 mm thick, with a mesh size of 100 x 100 mm. The net is fixed on via rings welded on to the boards and on the upper parts of the upright posts. The net encloses the court completely up to a total height of 3 metres.

On request soccer court can be extended with further board elements, but also with mini-goals, basketball rings or volleyball equipment.

The complete construction is made from aluminium.

- Order No. 115005** Dimension on request
- Order No. 115000** Dimension 30 x 10 m.
- Order No. 115010** Dimension 20 x 10 m.
- Order No. 115020** Dimension 18 x 10 m.
- Order No. 115030** Dimension 15 x 10 m.

Other dimensions on request.



*Subject to technical alterations



Player & Coaches Cabin Curved Roof

The player cabin curved roof is made from high grade aluminium profiles. The structure is made from square hollow profiles with a cross section of 40x40x3 mm. The lower section is line by special aluminium profiles. The back side of the player cabin is closed with polycarbonate sheets. The sheets are mounted in a special support profile, which have a groove to mount them. All seating profiles are powder coated. The cabin measures a height of 2.2 m with a roof overhang of 20 cm. The bottom depth of the cabin is 90 cm. The player cabin is manufactured in one piece. For export, the cabin is also available in a dismantled version. On request, the whole cabin can be powder coated. The cabin is available in various lengths.

- Order No. 117010** Length 2.00 m
- Order No. 117000** Length 3.00 m
- Order No. 117020** Length 4.00 m
- Order No. 117040** Length 5.00 m
- Order No. 117050** Length 6.00 m
- Order No. 117060** Length 7.00 m
- Order No. 117061** Length 8.00 m

Player & Coaches Cabin Curved Roof Model CLASSIC with Wheels

The wheels for player cabins are directly welded to the side/back part of the player cabin. The wheels measure a diameter of 200 mm. For player cabins below 5 m one set consists of 4 wheels. For player cabins with a length of 5 m or above another wheel is added at the back.

- Order No. 116990**



*Subject to technical alterations

Player Cabin Model "ECO 1"



The player cabin ECO 1 is made from high grade aluminium profiles. The structure is made from square hollow profiles with a cross section of 40x40x3 mm. The back side of the player cabin is closed with polycarbonate sheets. The sheets are mounted in a special support profile, which have a groove to mount them. All seating profiles are powder coated. The cabin measures a height of 2.2 m with a roof overhang of 15 cm. The bottom depth of the cabin is 83 cm. The player cabin is manufactured in one piece. For export, the cabin is also available in a dismantled version. On request, the whole cabin can be powder coated. The cabin is available in various lengths.

Order No. 117570	Length 2.00 m
Order No. 117575	Length 3.00 m
Order No. 117580	Length 4.00 m
Order No. 117585	Length 5.00 m
Order No. 117590	Length 6.00 m
Order No. 117595	Length 7.00 m

Player Cabin Model "ECO"

The player cabin ECO is made from high grade aluminium profiles. The structure is made from square hollow profiles with a cross section of 40x40x3 mm. The lower section is line by special aluminium profiles. The back side of the player cabin is closed with polycarbonate sheets. The sheets are mounted in a special support profile, which have a groove to mount them. It is equipped with plastic seats. The cabin measures a height of 2.2 m with a roof overhang of 20 cm. The bottom depth of the cabin is 90 cm. The player cabin is manufactured in one piece. For export, the cabin is also available in a dismantled version. On request, the whole cabin can be powder coated. The cabin is available in various lengths.

Order No. 117500	Length 2.00 m
Order No. 117510	Length 3.00 m
Order No. 117520	Length 4.00 m
Order No. 117530	Length 5.00 m
Order No. 117540	Length 6.00 m
Order No. 117560	Length 7.00 m



*Subject to technical alterations



Reserve Player Bench Model "Champ"

The player cabin Champ is made from high grade aluminium profiles. The structure is made from square hollow profiles with a cross section of 40x40x3 mm. The lower section is line by special aluminium profiles. The back side of the player cabin is closed with polycarbonate sheets. The sheets are mounted in a special support profile, which have a groove to mount them. It is equipped with specially manufactured leather seats. The cabin measures a height of 2.2 m with a roof overhang of 20 cm. The bottom depth of the cabin is 150 cm. The player cabin is manufactured in one piece. For export, the cabin is also available in a dismantled version. On request, the whole cabin can be powder coated. The cabin is available in various lengths.

- Order No. 117405/2 ROW** Reserve Player Bench Model "Champ" 2 ROW. 23 Seat
- Order No. 117405/2 ROW** Reserve Player Bench Model "Champ" 23 Seat, 2 ROW
- Order No. 117406/2 ROW** Reserve Player Bench Model "Champ" 12 Seat, 2 ROW
- Order No. 117410/2 ROW** Reserve Player Bench Model "Champ" 10 Seat, 2 ROW
- Order No. 117411/2 ROW** Reserve Player Bench Model "Champ" 8 Seat, 2 ROW
- Order No. 117412/2 ROW** Reserve Player Bench Model "Champ" 6 Seat, 2 ROW
- Order No. 117413/2 ROW** Reserve Player Bench Model "Champ" 4 Seat, 2 ROW
- Order No. 117414/2 ROW** Reserve Player Bench Model "Champ" 3 Seat, 2 ROW
- Order No. 117415/2 ROW** Reserve Player Bench Model "Champ" 2 Seat, 2 ROW
- Order No. 117416/2 ROW** Reserve Player Bench Model "Champ" 1 Seat, 2 ROW
- Order No. 117417/2 ROW** Reserve Player Bench Model "Champ" length on request, 2 ROW
- Order No. 117418/2 ROW** Reserve Player Bench Model "Champ" 16 Seat, 2 ROW



*Subject to technical alterations



Reserve Player Bench. 2 Row. Model "Champ"

The player cabin Champ double row is made from high grade aluminium profiles. The structure is made from square hollow profiles with a cross section of 40x40x3 mm. The lower section is line by special aluminium profiles. The seats of the cabin are arranged in two rows. The back row can be accessed via a staircase. The back side of the player cabin is closed with polycarbonate sheets. The sheets are mounted in a special support profile, which have a groove to mount them. It is equipped with specially manufactured leather seats. The seats of the cabin are arranged in two rows. The back row can be accessed via a staircase. The cabin measures a height of 2.2 m with a roof overhang of 20 cm. The bottom depth of the cabin is 200 cm. The player cabin is manufactured in one piece. For export, the cabin is also available in a dismantled version. On request, the whole cabin can be powder coated.

The cabin is available in various lengths.

Foot rest on request

- Order No. 116991** Foot rest made from aluminium for 2 m player cabin
 - Order No. 116992** Foot rest made from aluminium for 3 m player cabin
 - Order No. 116993** Foot rest made from aluminium for 4 m player cabin
 - Order No. 116994** Foot rest made from aluminium for 5 m player cabin
 - Order No. 116995** Foot rest made from aluminium for 6 m player cabin
 - Order No. 116996** Foot rest made from aluminium for 7 m player cabin
 - Order No. 116997** Foot rest made from aluminium for 14 m player cabin
 - Order No. 116998** Foot rest made from aluminium for player cabin
- Length on request

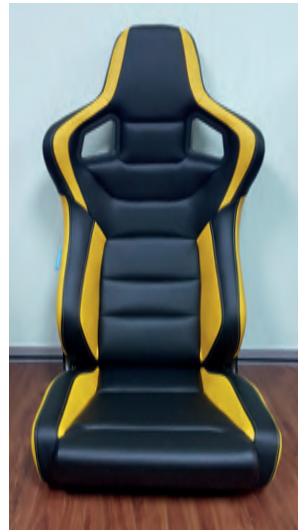

*Subject to technical alterations

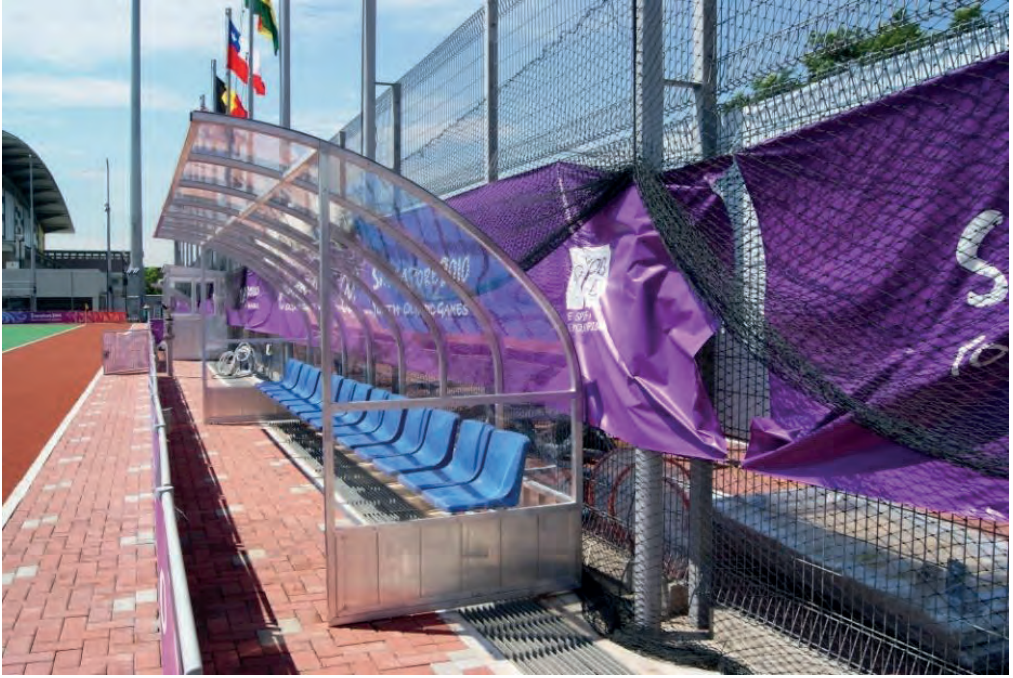

Player Cabins Model “SG”

The player cabin ‘SG’ is made from high grade aluminium profiles. The structure is made from square hollow profiles with a cross section of 40x40x3 mm. The lower section is line by special aluminium profiles. The back side of the player cabin is closed with polycarbonate sheets. The sheets are mounted in a special support profile, which have a groove to mount them. All seating profiles are powder coated. The cabin measures a height of 2.2 m with a roof overhang of 60 cm. The bottom depth of the cabin is 150 cm. The player cabin is manufactured in one piece. For export, the cabin is also available in a dismantled version. On request, the whole cabin can be powder coated. The cabin is available in various lengths.

- Order No. 117200** Length 2.00 m
- Order No. 117190** Length 3.00 m
- Order No. 117210** Length 4.00 m
- Order No. 117220** Length 5.00 m
- Order No. 117230** Length 6.00 m
- Order No. 117240** Length 7.00 m

Other length upon request.



*Subject to technical alterations



Portable Player Tunnel

The player tunnel is made from an anodized aluminium structure and covered with PVC. The aluminium profiles measure a cross section of 43x35 mm. The movement of the opening and closing is realized by means of scissors. The scissors measure a cross section of 50x13 mm and are made by aluminium as well. The joints are realized by aluminium casting parts. The slates are made from plastic, which drastically reduces the friction. The low friction allows an easy extension and withdrawal of the tunnel. The canvas is fixed to the arches at four points. The four-point suspension allows the canvas to hang smoothly and to be stretched evenly. The canvas weighs 620 gr/sqm and it is fireproof. (class M2). It is made from high tenacity polyester which is covered on both faces with PVC. The canvas is available in assorted colours. The tunnel measures a height of 2.3 m. The item is available in different widths.

Order No. 113000 Portable player tunnel. Width 2.00 m. High 2.30 m Import from Europe
Order No. 113010 Portable player tunnel. Width 2.00 m. High 2.30 m Import from Europe
Order No. 113020 Width 3.00 m. Height 2.30 m

*Subject to technical alterations



Dummies

The Dummy Set consists of 5 units of dummies. They are made from HDPE and are mounted on aluminium tubes. The height of the dummies can be adjusted.

Order No. 113050

The dummy free standing is one single dummy. It is made from HDPE and is mounted on aluminium tubes. The height of the dummy can be adjusted.

Order No. 113060

Dummy Set of TWO

5 Dummy's made of UV resistant, firm plastic, resistant to heat and cold, bright yellow. Size about 150 x 47 cm. Trolley for Dummy Set TWO. About 260 cm long made of aluminium. Used with the mobile dummy trolley. The Dummy Set TWO becomes a versatile and mobile penalty wall. The trolley can also be stored in small equipment rooms.

Order No. 113030

The soccerwall practice dummy is made from aluminium. It is inherently stable and air permeable. The height of the dummy is 180 m.

Order No. 113072

The soccer wall dummy trolley is made from steel. The trolley caters for up to 5 dummies. It is equipped with wheels to move the dummies comfortably.

Order No. 113071

The trolley for dummy set is made from aluminium. It is designed to fit up to 5 dummies. It is equipped with wheels for easy transport. The trolley makes the dummies to a versatile free kick wall. It also allows an easy storage for the dummies.

Order No. 113040

Linesman's Flag



The referee flag consist of the flag and a lightweight handle. The flag measures a size of 40x40 cm. The flags is red in colour.

Order No. 110535

The referee flag consist of the flag and a lightweight handle. The flag measures a size of 40x40 cm. The flags is yellow in colour.

Order No. 110730

The referee flag 'International' consist of the flag and a lightweight handle. The flag measures a size of 40x40 cm. The flags is red and yellow in colour.

Order No. 110746

The referee flag 'Quadro II' consist of the flag and a lightweight handle. The flag measures a size of 40x40 cm. The flags is red and yellow chequered.

Order No. 110745

*Subject to technical alterations

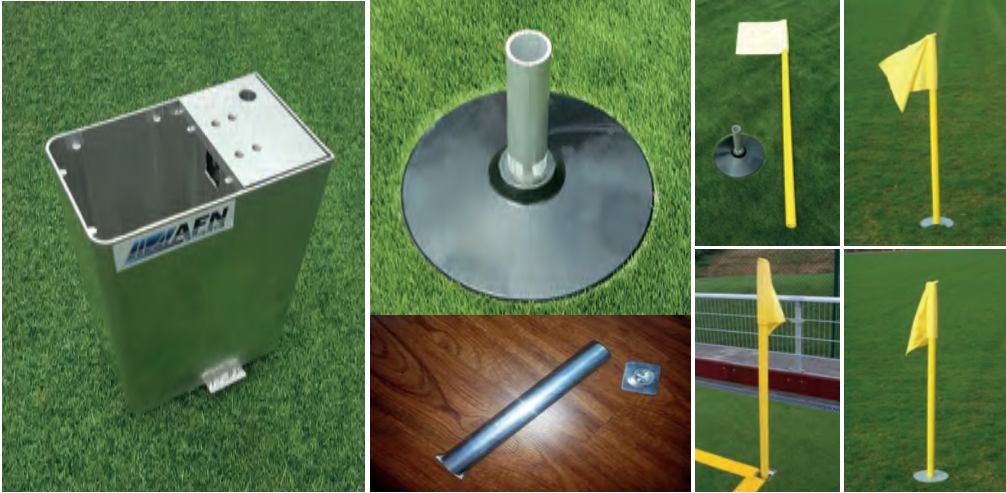

Flag Poles

The hockey flag pole consists of 3 parts: the base, the flag pole and the flag. There are two types of mobile bases: stainless steel (notched corner and round) and solid plastic. The flag pole for mobile bases measures a height of 1.6 m and is realized from a shatterproof non flexible plastic pole with a diameter of 50 mm. There are two types of ground sockets for fixed flag poles: standard and special ground socket. The depth of the ground socket is 20 cm. The socket is made from aluminium. The special ground socket is equipped with coat able cover.

The flag pole for fixed bases measures a height of 1.8 m and is realized from a shatterproof plastic pole with a diameter of 50 mm. There are two type of poles: flexible and non-flexible.

The flag itself measures 40x40 cm. It is available in assorted colours.

Order No. 90040

Mobile Bases

Order No	Material	Shape
90040	Stainless Steel	Corner Notched
90050	Stainless Steel	Round
110500	Plastic	Round

Fixed Bases

Order No	Type
110480	Standard Ground Socket with Lid
110490	Special Ground Socket with Coatable Cover

Poles

Order No	Type	Colour
110620	Non Flexible	Yellow
110530	Flexible	White

Flags

Order No	Colour
110540	Red
110550	White
110560	Yello
110570	Red White
110580	Blue White
110590	Yellow Orange
110600	Orange



*Subject to technical alterations

Ball Roll Ramp

The ball roll ramp is made from aluminium. It is used to test the characteristics of artificial turf for soccer and hockey. The item is in accordance with the test regulations of FIFA and FIH. The ramp is used to test the ball rolling. Therefore the ball is positioned at 1 m height on a 45 degree slope with two rails. The bottom end of the rail are bent to a radius of 500 mm. The item is collapsible.

Ball Roll Ramp Obligatory on pitches with FIFA homologation. Obligatory on pitches with FIFA homologation.

Order No. 118910

Ball Roll Ramp Obligatory on pitches with FIFA homologation and Hockey Fields. Obligatory on pitches with FIFA homologation.

Order No. 118911



Bag for Ball Roll Ramp

The bag for ball roll ramp is made from extra durable PVC. The bag can withstand almost any climate condition. It is cushioned with PU foam to prevent the ramp from damage. The bag is equipped with two larges handles, which allow an easy and comfortable transportation of the ball roll ramp. The bag is designed to cater sufficient space to store the ball roll ramp.

Order No. 118980

*Subject to technical alterations



Prism Gauge

The AFN Sports Prism Gauge is made from aluminium and unbreakable acrylic mirror. It can be used on artificial infill turf to determine fibre height and uniformity. The Grass Height Prism Gauge features graduated measurement lines that are viewed through the solid glass prism that are superimposed on the turf allowing you to measure the actual height of the free fibers. It is ideal for inspecting golf greens, baseball infields, cricket pitches, grass tennis courts or any finely manicured place cutting height and surface smoothness is important. It matches the new 2015 FIFA testing guidelines and shows 1 millimetre increments in a 175-mm length and a 140-mm height.

Order No. 118985



Straight Edge

The straight edge is made from high grade aluminium profiles. It measures a total length of 3.0 m. It consists of 3 parts, which can be easily dismantled and assembled for a comfortable transport. The alignment of the three parts can be adjusted with screws. The edge measures a cross section of 76x38 mm. It is equipped with a rope to pull it to the required locations. It is used to check the level of football pitches. The edge is also equipped with a measuring wedge to quantify the offset of the flatness. It is equipped with a handle and measures and offset of up to 20 mm. The wedge is marked every 2 mm.

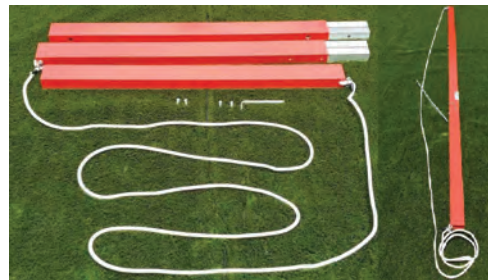

Order No. 118988 3 m Length

Order No. 118989 4 m Length

*Subject to technical alterations



Manual Soccer Substitute Board

The manual soccer substitute board is made from of shock- and weatherproof plastic. The board measures 85 x 40 cm. The number's height is 26 cm. It is suitable to display substitutes (INs and OUTs), extra time, scores, time-outs etc. The display can be adjusted simply and quickly. The adjustment is done by flipping over the coloured plates, which are hinged to the board. It displays numbers from 0-99. There are two yellow numbers for incoming player and two red numbers for the outgoing player.

Order No. 116060



Electronic Substitution Board Single Face

The single sided electrical display board shows incoming and outgoing payer's numbers or additional time. The display can be used indoor or outdoor. The numbers are displayed by high luminosity LEDs. It is equipped with a battery level indicator and automatically shuts down after 15 minutes. The numbers are displayed on one side of the display board.

Order No. 116000



Electronic Substitution Board Double Face

The double sided electrical display board shows incoming and outgoing payer's numbers or additional time. The display can be used indoor or outdoor. The numbers are displayed by high luminosity LEDs. It is equipped with a battery level indicator and automatically shuts down after 15 minutes. The numbers are displayed on both sides of the display board.

Order No. 116010

*Subject to technical alterations

*Subject to technical alterations



Line Marker - iGO™ Mini

The iGO™ Mini is a highly convenient solution for clubs with a small number of pitches. It features a 'plug and spray' system for quick and easy connection to Impact paints. Lightweight and compact in size, the The iGO™ Mini generates a consistently high quality line.



Line Marker - iGO™ De Luxe

The iGO™ De Luxe is the perfect solution for typical medium to high end volume users. The machine has a long-life rechargeable battery and will typically last for a full day of linemarking. iGO™ De Luxe also features a solenoid valve for instant paint cut-off, a disc-lift mechanism for ease of operation and pre-drilled holes for quick changes of the line width.

*Subject to technical alterations



Line Paints - Impact™

IMPACT is a general purpose ready-to-use linemarking paint, producing quality sports field markings. It contains Titanium Dioxide which brings a very white and bright appearance to the lines.

Available in these colours.



Line Paints - Impact™ Hard Surface

Impact™ Hard Surface is a high quality ready to-use, hard surface paint. It offers:

- Minimal set up time, ready to go in seconds. No diluting, no fuss.
- Superior Impact™ paint qualities
- Specially formulated for use on tarmac, concrete and other non-grassed surfaces
- Special binders and stickers
- White and colour options
- Applied using iGO™ and iGO™ Mini with cone nozzles
- Also see "Industrial Applications"

Available in these colours.



Line Paints - Synthetic Grass

New Synthetic Grass Paint is an advanced yet economical, durable ready-to-use paint formulation specially designed for synthetic grass surfaces. Compared to other similar paints, it offers:

- Minimal set up time, ready to go in seconds. No diluting, no fuss.
- Richer, deeper colours
- Improved flow properties
- Better adhesion to the leaf
- Stronger water repellence
- Longer storage stability (up to 12 months in cool conditions)
- Easy, accurate application by spraying through the iGO using a yellow flat fan nozzle



*Subject to technical alterations



Spray Line Marker FM 500

Spray line marking cart with automatically pressure generating. The needed spray pressure will be generated by pushing the cart with a newly developed impeller-pump (rear wheel-drive). The pump is made from aluminium and it's Hc-coated. The shaft is equipped with closed ball bearings and shaft seal ring. So the pump stands a loading capacity. For this reason can be used all variants of marking-paints known on the market.

The spraying unit is positioned in front of your view, flexibly for adjust in height and lateral and to operate easy by a hand lever at the guiding shaft. The line width is adjustable from 50 up to 150 mm. The cart has 2 plastic paint containers with 13 and 19 Litres, which you can both fill in with marking-paint or you fill only 1 container with paint and the second container with water for the later cleaning of the integrated spraying system and the pump. Each paint-container has its own stop-cock and can easily pick up for empty the container or for cleaning.

The cart has a strong steel construction with weather-proof powder-coated finishing. All parts are zinc plated. The big ballon-wheels 260 x 85 mm with roller bearing ensures an easy working and an exact lining. The guiding shaft is for variable height adjustable.

Further technical data:

Dimensions: ca. 760 x 550 x 790 mm
Wwn weight: ca. 22 kg packed in carton

The basic equipment includes 1 filling funnel 200mm Ø with sieve.

Order No. 110770

*Subject to technical alterations

Line Marking Trolley Roll-Liner

The line marking trolley ROLL-LINER is made from aluminium. The trolley is powder coated and measures 95 x 63 x 90 cm. The trolley is equipped with two pneumatic wheels. The trolley marks the line via its rollers in the front section of the trolley. The rollers are available in 50, 100 and 120 mm width. The handle for the trolley is height adjustable. The weight of the trolley is 21 kg. Its filling capacity is 15 litres. The balance of the marking fluid can be removed easily by the use of water.

Order No. 110760



*Subject to technical alterations

Ball Heading Post Two Side

The ball heading Post two sides is made from special aluminium profiles. The profile measures a cross section of 120x100x2.5 mm. The post is equipped with two balls, which are fixed on a rope. The item is used to improve the ball heading skills.

Order No.110810

The standard ground socket is made from aluminium. It is installed in the ground to slot in the soccer goal post. The ground socket matches the soccer goal profile exactly. The socket measures a length of 800 mm.

Order No.110860

The standard ground socket is made from aluminium. It is equipped with a special cover, which can be coated on site. It is installed in the ground to slot in the soccer goal post. The ground socket matches the soccer goal profile exactly. The socket measures a length of 800 mm.

Order No.110870



*Subject to technical alterations



Ball for Ball Heading

The ball for heading is a soccer ball size 5. Additionally it is equipped with a loop and swivel to fix it to the ball heading post.

Order No. 110840

AFN SOCCER Ball Size 5

The AFN soccer ball is hand cross-stitched and features a premium high-gloss PU cover, and AFN's top-of-the-line high density latex bladder to provide a consistent, quality touch with every contact. Designed for maximum durability. It's the soccer ball of choice for numerous state associations, high schools, premier & youth soccer organizations and junior clubs.

Order No. 119700



AFN Futsal Ball Size 4

The AFN futsal ball is hand cross-stitched and features a premium high-gloss PU cover, and AFN's top-of-the-line high density latex bladder to provide a consistent, quality touch with every contact.

Order No. 119701

*Subject to technical alterations

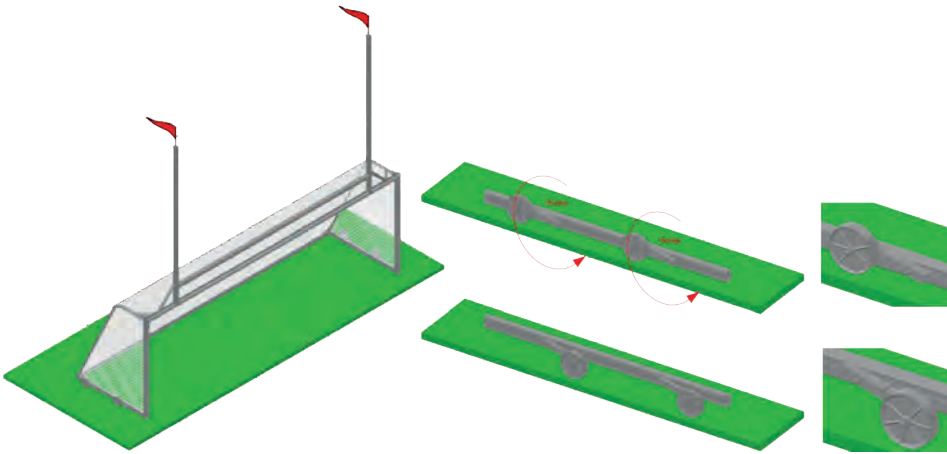

Practice Soccer Goal with Rugby

The practice soccer goal with rugby is made from special aluminium profiles. The inside dimension of this goal are 7.32x2.44 m. The front frame of the goal is made from oval 120x100x2.5 mm profile. The bottom frame is made from a rectangular hollow 80x60x3 mm. The top projection of the goal is 0.8 m. The lower projection measures 2.0 m. It is equipped with the INTERLOCK net hook system, which ensures that the nets hangs perfectly. The total height of the rugby goal post is 6.50 m. The goal is equipped with transport wheels.

- Order No. 110010** White powder coated
- Order No. 110020** Aluminium surface

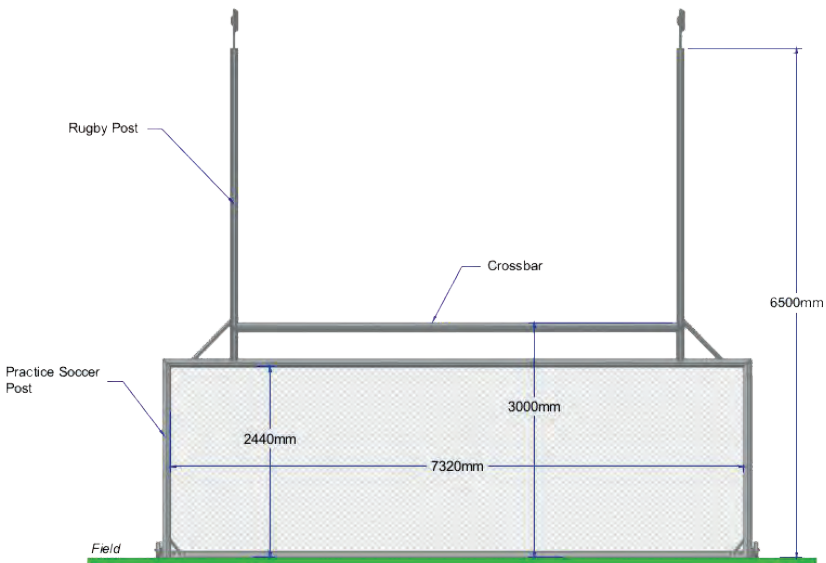

*Subject to technical alterations



Rugby Goal Post

The rugby goal post is made from special aluminium profiles. The cross section of the post measures 120x100 mm. The goal consists of two vertical posts and a cross bar. The cross bar can be fixed to the vertical posts with two screws. The final height of the cross bar also can be adjusted on site. The top edge of the cross bar needs to be 3 m above the ground level. The distance between the vertical posts is 5.6 m. The goal is available in aluminium finish or powder coated. The vertical posts are available in various lengths.

Order No	Height	Colour
112050	6.5m	Aluminium Surface
112051	6.5m	White Powder Coated
112000	9m	Aluminium Surface
112001	9m	White Powder Coated
112040	10m	Aluminium Surface
112041	10m	White Powder Coated
112030	11m	Aluminium Surface
112031	11m	White Powder Coated
112010	12m	Aluminium Surface
112011	12m	White Powder Coated



Padding For Rugby Goal Post

The rugby padding is made from a foam core and a PVC cover. The padding measures a height of 2.0 m x 0.55 x 0.55 m. Thickness is 150 mm. The PVC is weather resistant.

- Order No. 112080** 2.00m. One Color, Set (4 pcs)
- Order No. 112080/2C** 2.00m. Two Color, Set (4 pcs)
- Order No. 112080/4C** 2.00m. Four Color, Set (4 pcs)

*Subject to technical alterations

Ground Socket For Rugby



The special ground socket for rugby is made from a special aluminium profile. It is equipped with a special cover, which can be coated on site. It is installed in the ground to slot in the rugby goal post. The ground socket matches the rugby goal profile exactly.

Order No. 112060



Our hinged aluminium ground socket is fitted with a to and from swivel element which allows the rugby goal post uprights to be set up quickly and easily. With lid chamber and attached lid which can be covered on site to suit the various surfaces.

Order No. 112065



The standard ground socket is made from aluminium. It is installed in the ground to slot in the rugby goal post. The ground socket matches the rugby profile exactly.

Order No. 112070



The hinge for rugby goal post is made from special extra strong aluminium profiles. The structure is reinforced with stainless steel bars. All screws are made from stainless steel as well. The structure allows a more comfortable erecting of the goal post. The hinge can be slotted in the ground socket easily. The post is slotted in the socket on top of the hinge. This leads to an increased stability during the installation of the goal.

Order No. 112075

*Subject to technical alterations

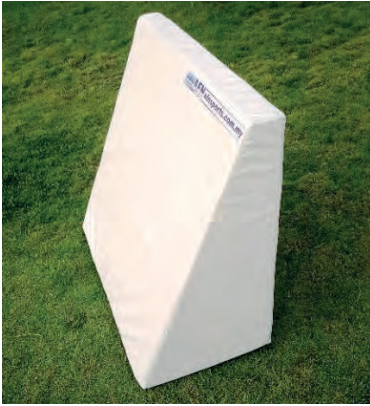

Rugby Protector Barrier

The rugby protector barrier is made from a foam core and a weatherproof PVC cover. It measures a length of 2.0 m. The height is 0.9 m. The width raises from 9 cm on top to 60 cm at the bottom. The barrier is used to divide fields during training in a safe manner.

Order No. 112084



Flag On Rugby Post

The flag on the rugby goal post consists of the aluminium pole and the flag. The flag can be easily fixed to the rugby goal post with a screw. One set consists of two flags. The flag is available in various colours.

Order No. 112100



Padding For Corner Flag

The padding for corner flag is made from a foam core and a PVC cover. The padding measures a height of 1.0 m and thickness of 50 mm. The PVC is weather resistant. The item is available in various colour. It is also available in multiple colours

Order No 112083 Single Colour

Order No 112083/2C Dual Colour

Order No. 112083/4C Quad Colour

**Subject to technical alterations*

'Flap Down Net System'



The 'flap down' net suspension system is a fully integrated and closed system. This means, all suspension parts are placed inside the goal post profile. The slot for the net suspension is covered to allow a smooth and safe appearance of the goal post.

Therefore, there are no sharp edges or corners at the goal post, which can cause harm to players. The suspension is realized by an aluminium profile, which holds the nets in place. The profile is designed to leave space for the net to be fixed perfectly. The whole system is covered with a flap. The flap is mounted, so it can open and close like a door. The flap can be locked to secure the net in the position. The design is registered of patent in Malaysia and Germany.

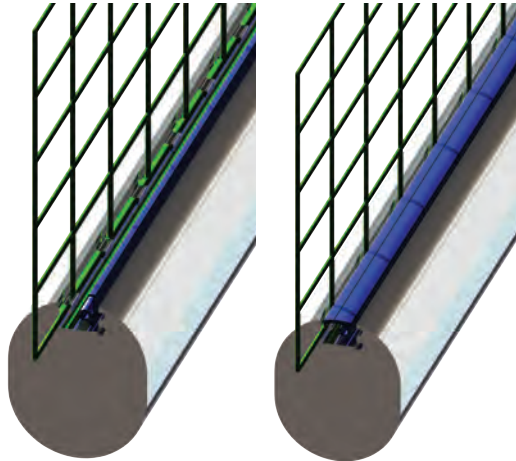

Order No	System	Usage	Dimension
110055	FLAP DOWN NET HOOK	Goal Post	7.32 x 2.44 m
110056	FLAP DOWN NET HOOK	Goal Post	5.00 x 2.00 m
110057	FLAP DOWN NET HOOK	Goal Post	3.00 x 2.00 m

*Subject to technical alterations

Interlock System



The INTERLOCK net hook system is a fully integrated system. This means all suspensions parts are placed inside the goal post profile. The hooks are placed in a specially designed slot in the goal post profile.

The hooks are placed approx. every 30 cm in the slot to keep the net in place and hang perfectly. The hook is shaped ergonomically and no adjustment has to be done to it. On the horizontal posts the hooks face the direction of the net due to gravity. On the vertical posts they are rotated against each other so they lock the movement of the net in both direction. With the INTERLOCK net hook system the of a goal post can be installed within minutes without any usage of tools.



Integrated Net Hook System

*Subject to technical alterations

